



# AC16

## Ultra Compact 2-way Loudspeaker System with 1 - 6.5" LF

### Key Features:

- ▶ Ultra compact enclosure
- ▶ 165 mm (6.5 in) LF transducer
- ▶ 90° x 90° Progressive Transition™ waveguide with a 25 mm (1 in) exit compression driver
- ▶ Dual Neutrik NL4 connectors plus screw terminals
- ▶ Multiple Attachment Points for Ultimate Flexibility

### Applications:

- ▶ Performing Arts Facilities
- ▶ Houses of Worship
- ▶ Sports Facilities
- ▶ Multi Media Spaces
- ▶ Retail Spaces
- ▶ Presentation Suites
- ▶ Educational Facilities
- ▶ Portable Audio-Visual Systems

The AC16 is an ultra-compact full-range loudspeaker system designed to provide maximum bandwidth and SPL in a single system package and yet be visually unobtrusive. The enclosure design allows for installation very close to walls and ceilings making it an ideal choice for under balcony, column, or wall mounting. The high frequency device is a 1" exit compression driver integrated into a newly designed 90° x 90° PT™ (Progressive Transition) waveguide providing even coverage throughout the intended listening area. The combination exhibits smooth power response resulting in extremely natural voicing. The AC16 utilizes a 6.5" Symmetrical Field Geometry (SFG™) LF Transducer with a copper-clad aluminum edge wound 2" voice coil and a copper-clad pole piece that improves performance by reducing voice coil inductance and distortion.

The rugged multi-ply hardwood enclosure is designed to work in the vertical plane as well as in the horizontal plane. Mounting points are provided for an optional U-bracket and for an OmniMount® type bracket. The AC16 is also equipped with attachment points located on the bottom of the enclosure for a stand mount accessory.

The rugged plywood enclosure features JBL's textured DuraFlex™ finish and is equipped with a heavy duty powder coated steel, foam-backed grille.



### Specifications:

<b>System:</b>	
Frequency Range (-10 dB):	55 Hz - 20 kHz
Frequency Response (+/-3 dB):	65 Hz - 18 kHz
Horizontal Coverage:	90°
Vertical Coverage:	90°
Directivity Factor (Q):	7 (avg, 500 Hz - 16 kHz)
Directivity Index (DI):	8 dB (avg, 500 Hz - 16 kHz)
System Sensitivity <sup>1</sup> :	90 dB SPL/1W/1m
Rated Maximum SPL (1m) <sup>2</sup> :	110 dB
System Nominal Impedance:	16 Ohms
Long-Term System Power Rating <sup>3</sup> : (Continuous/Program/Peak):	160 W / 320 W / 640 W
AES Standard Power Rating <sup>4</sup> :	250 W
Crossover:	2.4 kHz
<b>Transducers:</b>	
<u>Low Frequency Driver:</u>	1 x JBL 226J, 165 mm (6.5 in) SFG™ driver with 50 mm (2 in) edge wound voice coil
<u>High Frequency Driver:</u>	1 x 2414H 25 mm (1 in) exit compression driver, 25 mm (1 in) voice coil
<u>High-Frequency Waveguide:</u>	PT-B99HF-1
<b>Physical:</b>	
Enclosure:	12 mm and 15 mm exterior grade multi-ply hardwood plywood
Suspension Attachment:	5 x M8 points; 1 top, 3 bottom, 1 rear. 4 x M6 rear for OmniMount® 30.0 and MultiMount® MM-022-BT, MM-024-BT, MM-020-CM.
Finish:	Black DuraFlex™ finish. White (-WH) available upon request.
Optional Weather Resistant Versions <sup>5</sup> :	WRC & WRX available upon request
Grille:	Powder coated 16 gauge perforated steel, acoustically transparent foam backing (grille cloth backing on white units)
Input Connectors:	Neutrik Speakon® NL4 (2 wired in parallel), plus CE-compliant covered barrier strip terminals. Barrier terminals accept up to 5.2 sq mm (10 AWG) wire or max width 9 mm (.375 in) spade lugs. NL4's +1/-1 in parallel with barrier strip (+2/-2 loop through).
Environmental Specifications:	Mil-Std 810; IPx3 per IEC529. For higher environmental ratings, use WRC or WRX.
Dimensions (H x W x D):	381.0 x 199.4 x 226.1 mm (15.0 x 7.8 x 8.9 in)
Weight:	7.2 kg (15.8 lb)
Optional Accessories:	MTU-16 U-Bracket 365469-001, M8 x 38 Tee Knot Thumbscrew kit for use with BMB-200k or K & M 195/8 stand mount accessory

<sup>1</sup>On axis SPL measured in far field and referenced to 1 meter by inverse square law. Average from 300 Hz to 16 kHz.

<sup>2</sup>Calculated based on system sensitivity and continuous power handling.

<sup>3</sup>IEC shaped pink noise, 6 dB crest factor, 100 hour duration.

<sup>4</sup>AES standard 2 hour duration, with IEC system noise spectrum.

<sup>5</sup>WRC for outdoor placement where the loudspeaker will be sheltered from direct exposure to the elements. WRX for direct exposure or extreme environments, such as tropical or beach, or in areas with salt air, extreme high humidity or rapid changes in temperatures. See WRC/WRX configuration sheet for details.

# ▶ AC16 Ultra Compact 2-way Loudspeaker System with 1 - 6.5" LF

Beamwidth

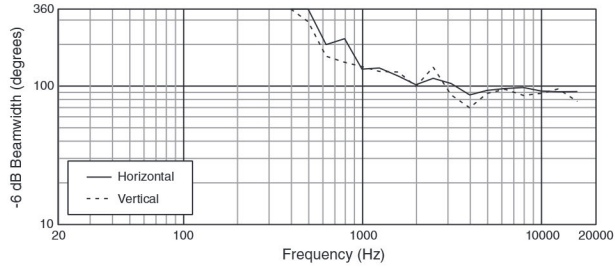

Horizontal Off-Axis Frequency Response

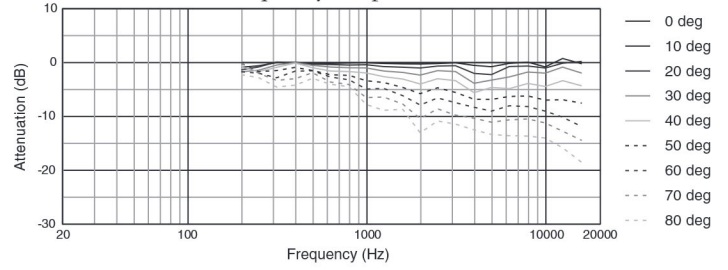

Directivity Index, Q

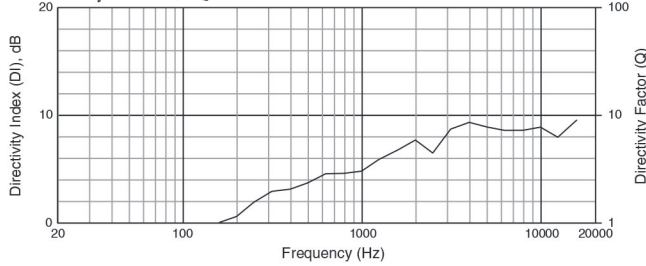

Vertical Up Off-Axis Frequency Response

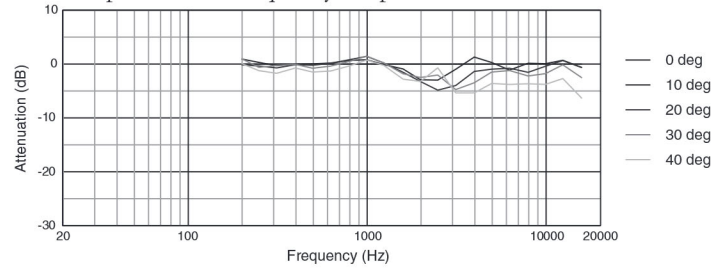

Frequency Response, 1W/1m

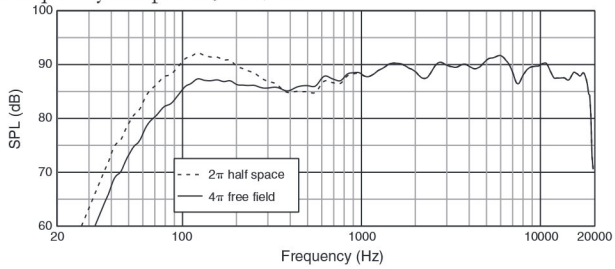

Vertical Down Off-Axis Frequency Response

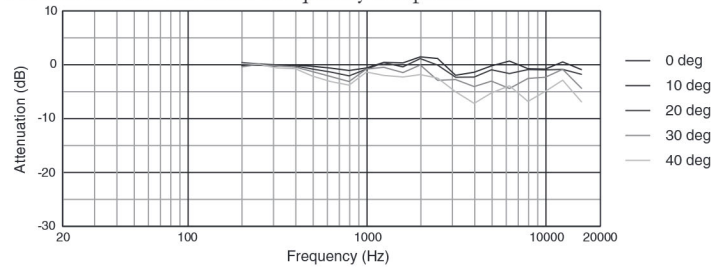

## Dimensions

Dimensions in "in" (mm)

For more detailed dimensional information, refer to Application Data Sheet.

For AE & AE Compact Series WRC and WRX versions please visit the JBL Pro website at <http://www.jblpro.com/www/products/installed-sound/ae-series#.V63kVfkrLIV> to download Drawings.

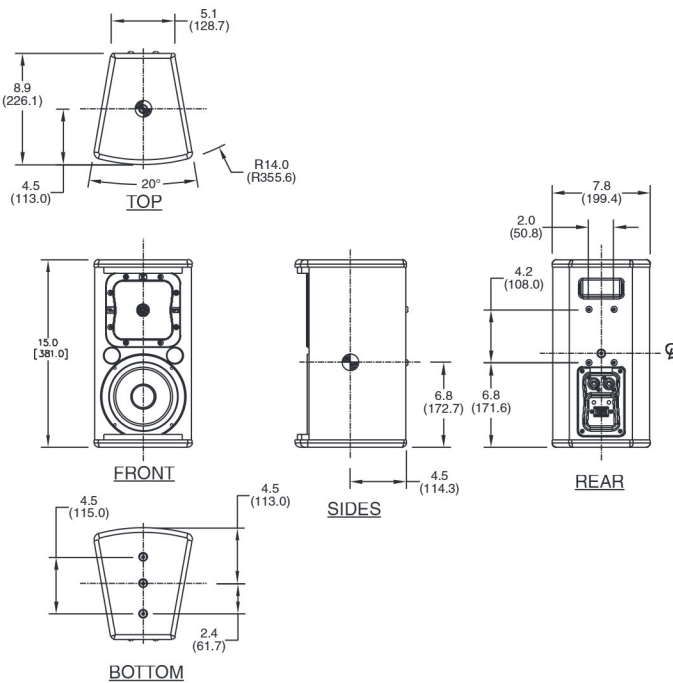

## Impedance

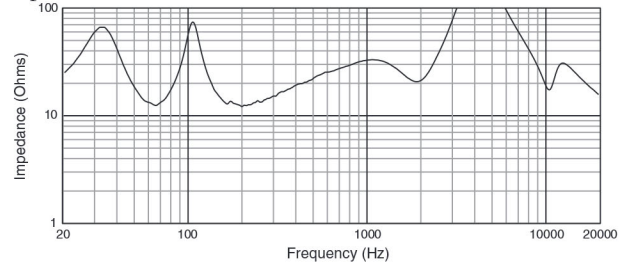

Measurements obtained in full passive crossover mode with no signal processing. Graphs are from unaltered measured data.

### Attachment Points For Third Party Accessories:

Bottom: Ultimate Support™ BMB-200K; Konig & Meyer 195/8

Rear: OmniMount® 30.0; Konig & Meyer 24470; MultiMount® MM-022-BT, MM-024-BT, MM-020-CM



JBL Professional  
8500 Balboa Boulevard, P.O. Box 2200  
Northridge, California 91329 U.S.A.

© A Harman International Company  
© Copyright 2016 JBL Professional

SS AC16  
CRP 5M  
8/16